

Mirplay[®]
school

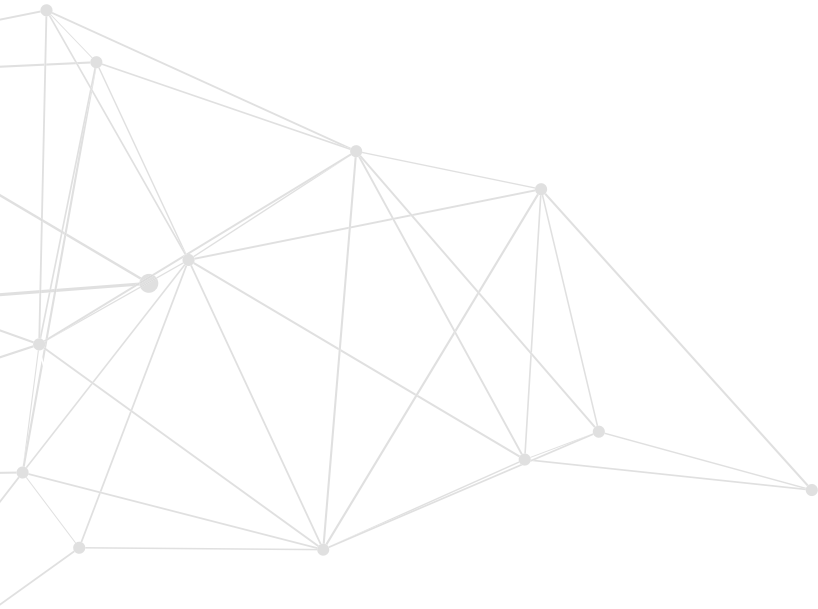



Mirplay[®] school

Catálogo | Brochure | Catalogue | Catàleg
2020

Creemos que todas las escuelas deberían ser un espacio flexible y motivacional para aprender, compartir e inspirar.

We believe schools should be flexible and motivational environments in which to learn, share and inspire.

Nous croyons que toutes les écoles devraient être un espace flexible et motivant pour apprendre, partager et inspirer.

Creiem que totes les escoles haurien de ser un espai flexible i motivacional per aprendre, compartir i inspirar.



Mirplay®

Welcome to Mirplay

Nuestra pasión es crear productos con diseños atractivos, de calidad y eficientes adaptables a los nuevos métodos de educación y adecuados a las nuevas tecnologías.

Para ello ponemos todo nuestro conocimiento en el diseño y fabricación de mobiliario escolar.

Permitiendo así, transformar áreas tradicionales en espacios flexibles, activos y que aporten valor a la enseñanza.

Espacios que favorezcan la relación y el bienestar del profesor y el estudiante.

Notre passion est de créer des produits avec un design attractif, de haute-qualité et efficients adaptables aux nouvelles méthodologies d'enseignement et adéquats aux nouvelles technologies.

Pour cela nous mettons tout notre savoir-faire dans la conception et fabrication de mobilier scolaire.

Permettant ainsi de transformer des zones traditionnelles en espaces flexibles, actifs et qui apportent de la valeur à l'enseignement.

Des espaces qui favorisent la relation et le bien-être du professeur et l'élève.

Our passion is to create and design quality and efficient products with attractive designs, adaptable to the new education trends and adequate to the new technologies.

This is why we put all of our knowledge into designing and manufacturing school furniture.

Thus allowing us to transform traditional environments into flexible and active areas which provide added value to teaching.

Areas that favor the relation and well-being of the student and the teacher.

La nostra passió és crear productes amb dissenys atractius, de qualitat i eficients adaptables als nous mètodes d'educació i adequats a les noves tecnologies.

Per això posem tot el nostre coneixement en el disseny i fabricació de mobiliari escolar.

Permetent així, transformar àrees tradicionals en espais flexibles, actius i que aportin valor a l'ensenyament.

Espais que afavoreixin la relació i el benestar del professor i l'estudiant.



Engineering



Production



Stock 11.000 m²



Drop shipping

Mi ARCHITECTURE

convertimos

una escuela tradicional en espacios que transmitan

we transform

traditional schools into contemporary learning environments

nous transformons

une école traditionnelle en espaces de transmission

convertim

una escola tradicional en espais que transmetin

MIRPLAY EXPERIENCE:

1



THE SCHOOL

Debería ser un espacio práctico, flexible y de inspiración para aprender.

Should be a practical, flexible and inspiring learning space.

Devrait être un espace d'apprentissage pratique, flexible et inspirant.

Hauria de ser un espai pràctic, flexible i d'inspiració per a aprendre.

2



MIRPLAY

Utiliza el conocimiento para desarrollar y diseñar espacios de aprendizaje contemporáneo.

Uses the knowhow to develop and design spaces to create contemporary learning environments.

Utilise le savoir-faire pour développer concevoir des espaces afin de créer des environnements d'apprentissage contemporains.

Utilitza el coneixement per desenvolupar i dissenyar espais per crear entorns d'aprenentatge contemporani.

3



TRANSFORMATION

Basado y construido priorizando el proyecto pedagógico de cada centro escolar.

Based and built prioritizing the pedagogical side according to the school project.

Basée et construite en privilégiant le côté pédagogique selon le projet d'école.

Basat i construït prioritzant el projecte pedagògic de cada centre escolar.

4



GREAT RESULTS

Damos soporte a la escuela a lo largo del proyecto para garantizar que estos diseños se implementen profesionalmente, sin estrés y dentro del presupuesto.

We support the school throughout the project to ensure that these designs are implemented professionally, stress free and within budget.

Nous soutenons l'école tout au long du projet pour nous assurer que ces conceptions sont mises en œuvre de manière professionnelle, sans stress et dans les limites du budget.

Donem suport a l'escola durant tot el projecte per garantir que aquests dissenys s'implementin de forma professional, sense estrès i dins del pressupost.

MiARCHITECTURE

TRANSFORMA TU CENTRO EDUCATIVO

TRANSFORM YOUR EDUCATIONAL CENTER

TRANSFORMEZ VOTRE CENTRE ÉDUCATIF

TRANSFORMA EL TEU CENTRE EDUCATIU

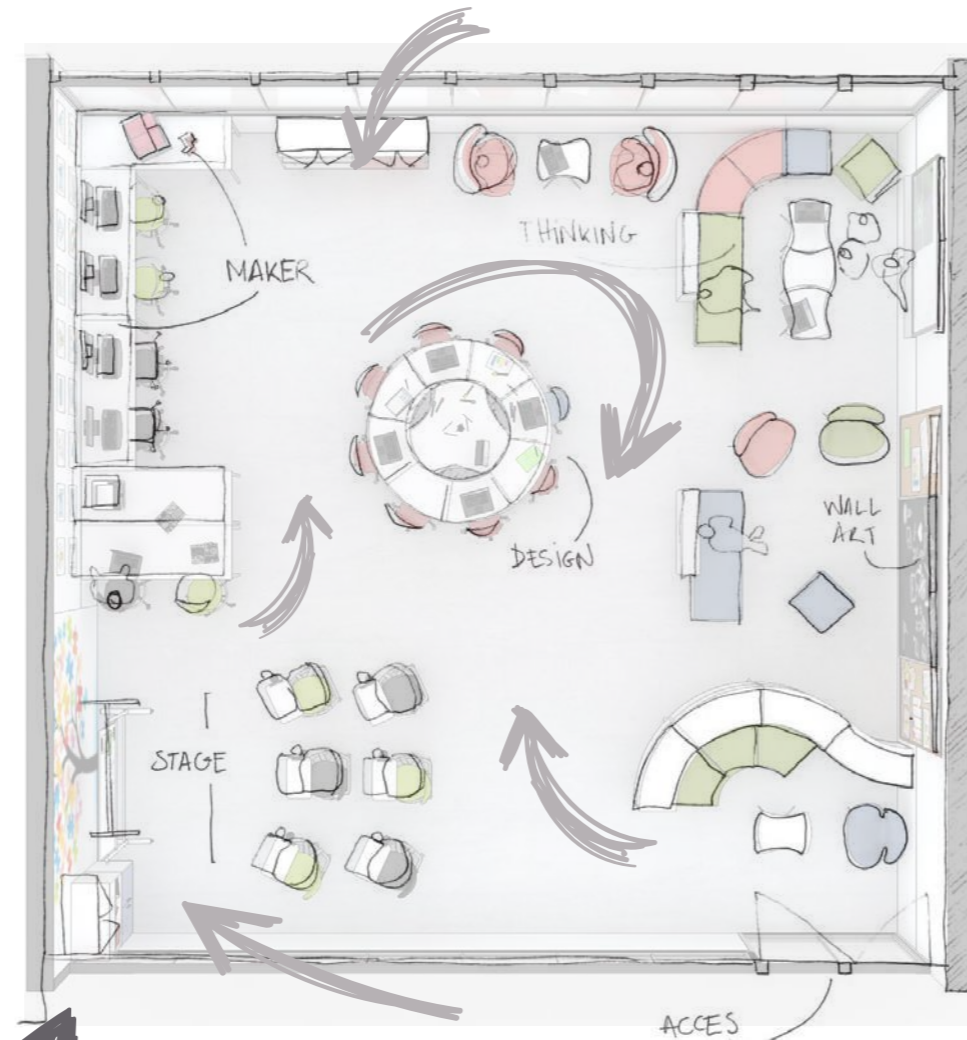
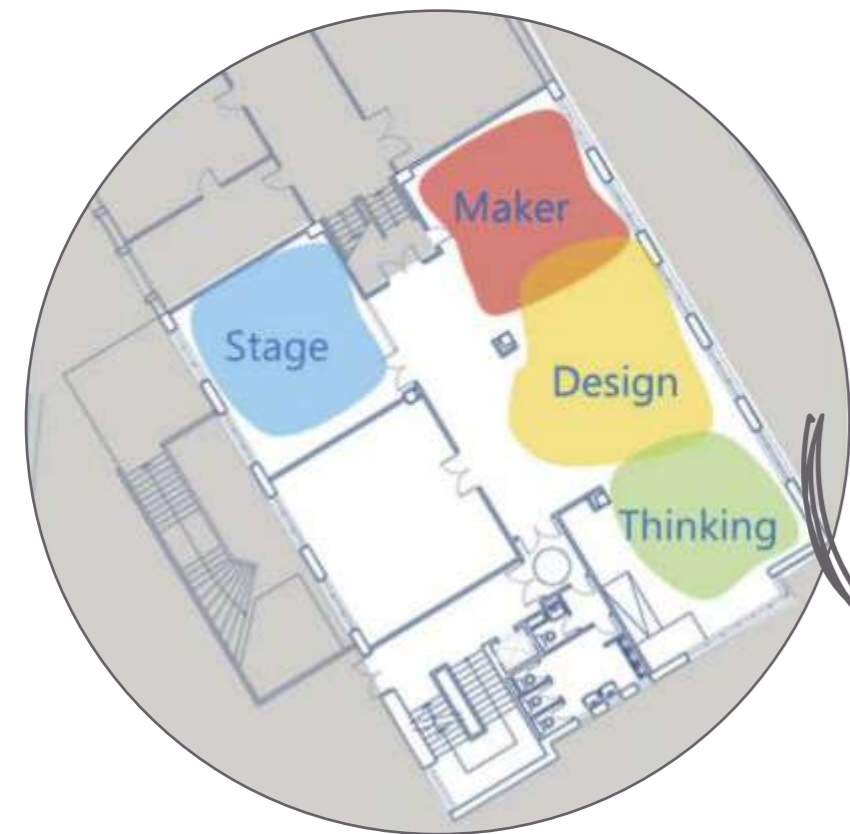

espacios

que transmiten sensaciones

spaces

that inspire

espaces

qui transmetten des sensations

espais

que transmeten sensacions

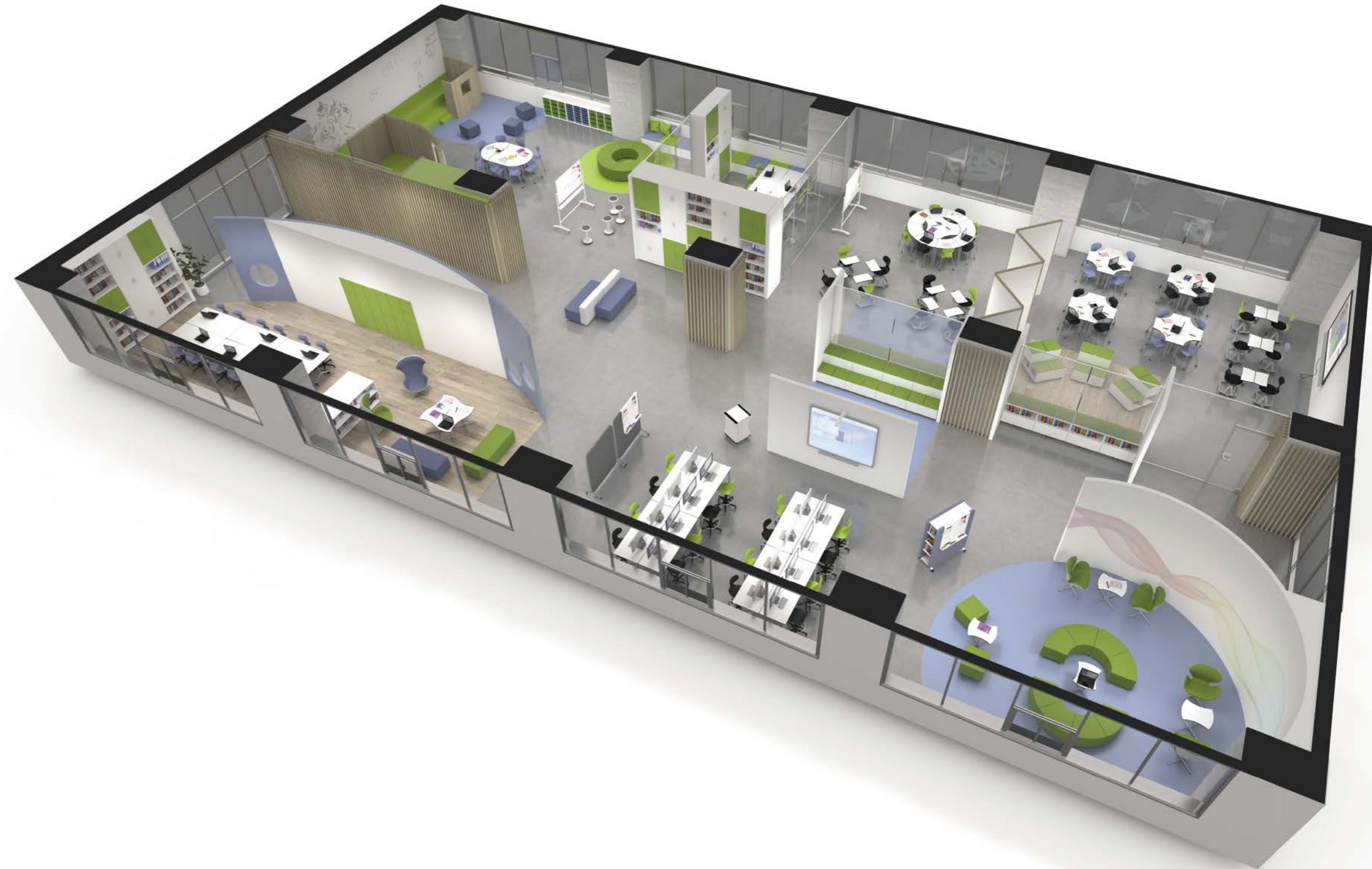

COMMON SPACES

La escuela debe ser un espacio donde sentirse cómodo. Con un ambiente habitable y amable que favorezca la seguridad afectiva y un desarrollo personal equilibrado.

School should be a space where you must be comfortable at. A warm and friendly environment promotes affective safety and balanced personal development.

L'école, un espace où se sentir à l'aise. Avec un cadre de vie agréable, propice à la sécurité affective et à l'épanouissement personnel.

L'escola ha de ser un espai on sentir-se còmode. Amb un ambient habitable i amable que afavoreixi la seguretat afectiva i un desenvolupament personal equilibrat.



Espacios que requieren de la neutralidad suficiente para albergar actividades muy diversas.

Des espaces suffisamment neutre pour se prêter à des activités variées.

Spaces that must work for all stakeholders to support a variety of activities.

Espais que requereixen de la neutralitat suficient per acollir activitats molt diverses.



Movimiento

Vestíbulos, pasillos y salas de actos se configuran de forma flexible.

Mouvement

Les vestibules, les couloirs et les salles de conférences s'agencent en souplesse.

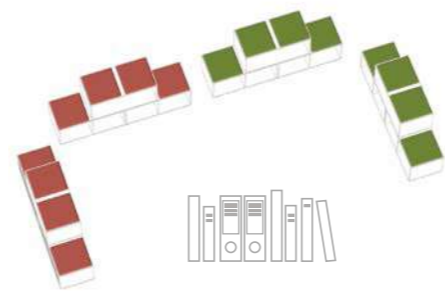
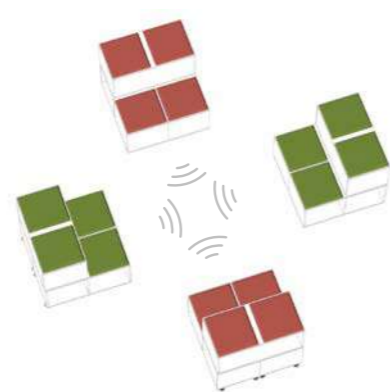
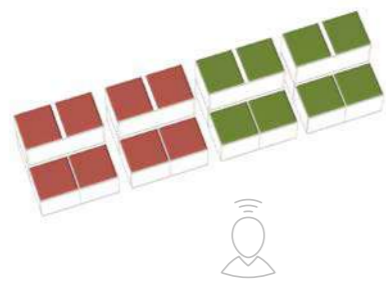
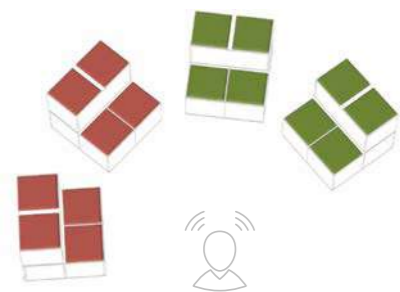

Movement

Halls, corridors and libraries that can be interchangeable in breakout areas, offices, meeting and dining rooms.

Moviment

Vestíbuls, passadissos i sales d'actes es configuren de manera flexible.

¿Cómo funciona? Mira el vídeo aquí:

How does it work? Watch the video here:

Comment ça fonctionne ? Regarde la vidéo ici:

Com funciona? Mira el video aquí:

YouTube





Diseño innovador Un espacio, múltiples utilidades.

Innovative design One space, multiples uses.

Conception innovante Un espace, plusieurs utilisations.

Disseny innovador Un espai, múltiples utilitats.



EDUCA

6-18

La polivalencia de los espacios es clave para trabajar la autonomía de los alumnos. Estimulan la experimentación y la creatividad, que fomenten el aprendizaje activo, colaborativo y dinámico.

Multi-functional spaces to support independent learning. These environments stimulate the senses, experimentation and creativity, and that foster active, participatory, collaborative and dynamic learning.

La polyvalence des espaces est clé pour améliorer l'autonomie des élèves. Ces ambiances stimulent les sens, l'expérimentation et de la créativité, et qui suscitent l'apprentissage actif, participatif, collaboratif et dynamique.

La polivalència dels espais és clau per treballar l'autonomia dels alumnes. Estimulen l'experimentació i la creativitat, que fomenten l'aprenentatge actiu, col·laboratiu i dinàmic.



Dinamismo

Los espacios se personalizan y acontecen contextos que reflejan una identidad cultural y pedagógica propia.

Dynamisme

Les espaces personnalisés forment des contextes empreints d'une identité culturelle et pédagogique

Dynamism

Spaces are tailored to reflect your needs, your schools identity and individual teaching styles.

Dinamisme

Els espais es personalitzen i esdevenen contextos que reflecteixen una identitat cultural i pedagògica pròpia.

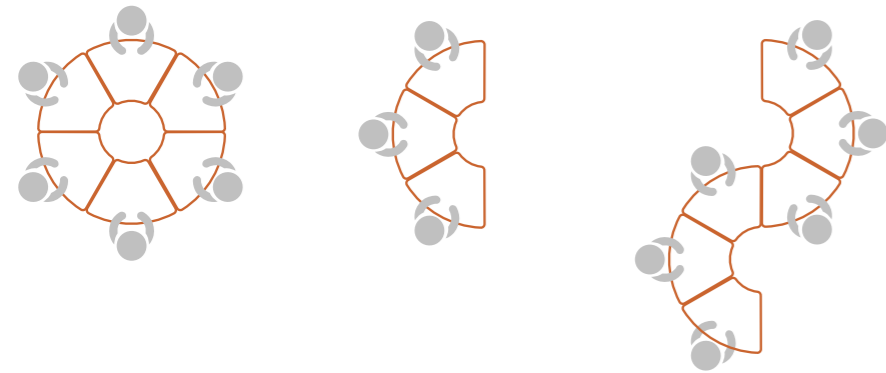

¿Cómo funciona? Mira el vídeo aquí:

How does it work? Watch the video here:

Comment ça fonctionne ? Regarde la vidéo ici:

Com funciona? Mira el video aquí:

You Tube



Espacios versátiles

Versatile spaces

Espaces évolutifs

Espais versàtils

Desdibujar los límites

Limitless layouts

Estomper les limites

Desdibuixar els límits

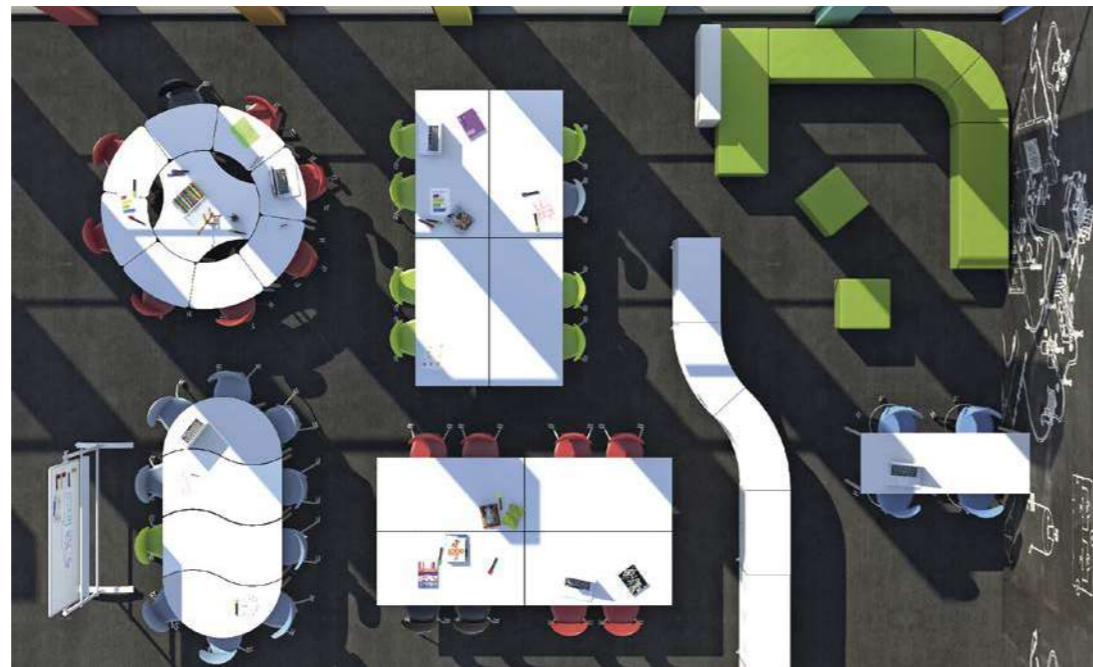

Confort

Un entorno acogedor facilita un ambiente tranquilo que potencia el buen clima entre los alumnos.

Confort

Un milieu accueillant favorise un environnement tranquille qui stimule la bonne ambiance entre les élèves.

Comfort

A warm and peaceful environment promotes a good atmosphere among students.

Confort

Un entorn acollidor facilita un ambient tranquil que potencia el bon clima entre els alumnes.



Espacios sin jerarquías

Spaces without hierarchies

Espaces non hiérarchisés

Espais sense jerarquies



Son tiempos de cambio

Espacios innovadores abren nuevas perspectivas en la educación.

Il est temps de changer

Les espaces innovants s'ouvrent aux nouvelles perspectives d'enseignement.

It's time for a change

Innovative facilities open up new opportunities in education.

És temps de canviar

Espais innovadors obren noves perspectives en l'educació.

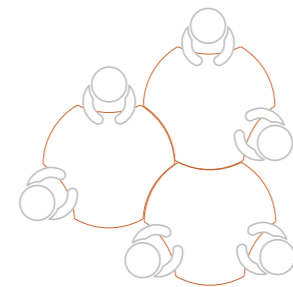
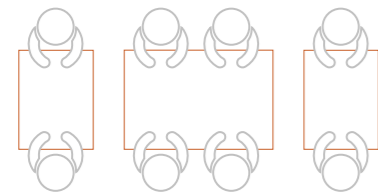

Espacios abiertos y con carácter

Fundamento de la nueva transversalidad espacial.

Open and interesting spaces

Foundation of a new spatial cross-disciplinarity.

Espaces ouverts qui ont du caractère

Fondamentaux de la nouvelle transversalité spatiale.

Espais oberts i amb caràcter

Fonaments de la nova transversalitat espacial.



Ambientes que estimulan los sentidos.

Inspiring and stimulating spaces.

Ambiances qui stimulent les sens.

Ambients que estimulen els sentits.



ZTOOL

Y tú, ¿Cómo la utilizarías?
And you, how would you use it?
Et vous, comment l'utiliseriez-vous?
I tu, com la utilitzaries?

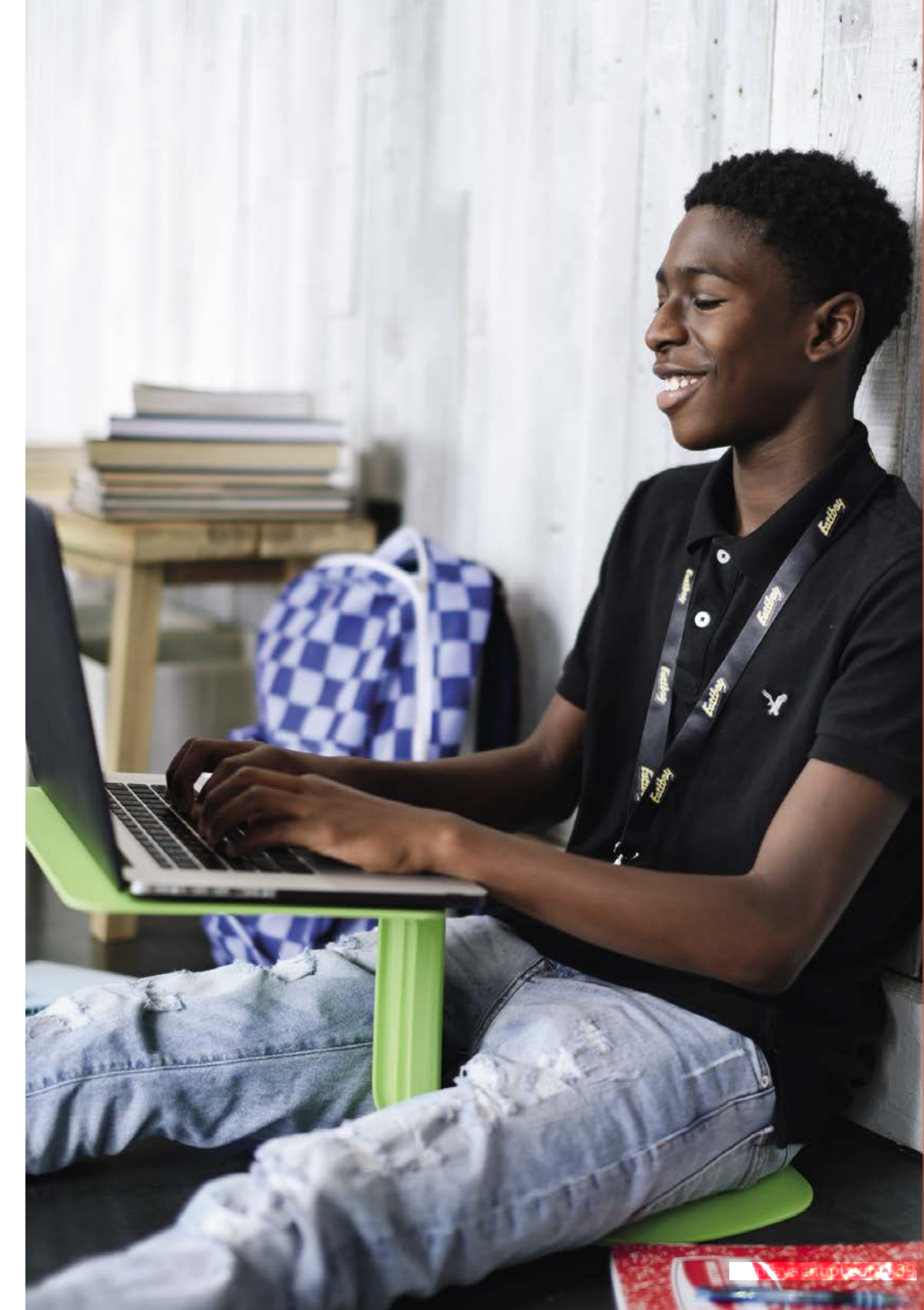



¿Cómo funciona? Mira el vídeo aquí:

How does it work? Watch the video here:

Comment ça fonctionne ? Regarde la vidéo ici:

Com funciona? Mira el video aquí:

You Tube



ZTOOL

COLLABORATIVE active learning

EDUCA 6-18



EDUCA 6-18

Aulas tecnológicas

Espacios que se adaptan a las necesidades cambiantes del proceso de aprendizaje.

Salle technologiques

Espaces multifonctions flexibles qui s'adaptent aux nécessités et à l'évolution du processus d'apprentissage.

Technological classrooms

Spaces that can be adapted to the changing needs of learners.

Aules tecnològiques

Espais multifuncionals i flexibles, que s'adapten a les necessitats canviants del procés d'aprenentatge.



EDUCA

3-6

Un entorno acogedor facilita un ambiente tranquilo que potencia el buen clima entre los alumnos, su bienestar emocional y predispone al alumno para un mejor aprendizaje.

A comfortable environment promotes outstanding teaching and learning. Our designs are beautiful, flexible and not only support academic studies but also promote positive wellbeing.

Un environnement accueillant et un cadre apaisant renforcent la camaraderie, le bien-être émotionnel et prédisposent les élèves à un meilleur apprentissage.

Un entorn acollidor facilita un ambient tranquil que potencia el bon clima entre els alumnes, el seu benestar emocional i predisposa a l'alumne per un aprenentatge millor.



La flexibilidad del mobiliario y de los espacios posibilitan ambientes cambiantes y que favorecen múltiples dinámicas.

La flexibilité du mobilier permet de créer des ambiances évolutives et de stimuler des multiples dynamiques.

Flexible furniture and spaces allow the environment to be adapted for dynamic teaching.

La flexibilitat del mobiliari possibilita ambients canviants i afavoridors de múltiples dinàmiques.



Creatividad

El diseño de los espacios ofrece posibilidades de juego, de manipulación y de expresión propias de sus usuarios.

Creativity

The design of the spaces offers many possibilities to play and to express creativity.

Créativité

La conception des espaces offre différentes possibilités de jeux, manipulation et expression propres à leurs petits utilisateurs.

Creativitat

El disseny dels espais ofereixen possibilitats de joc, de manipulació i d'expressió propis dels seus usuaris.



Movimiento

Los niños habitan y reconstruyen poco a poco los espacios, los hacen suyos.

Movement

Children step by step can develop their literacy skills in private, safe, areas or more open spaces for inspiring and fun storytelling.

Mouvement

Les enfants habitent les espaces qu'ils reconstruisent peu à peu et se réapproprient.

Moviment

Els nens habiten i reconstrueixen a poc a poc els espais, els fan seus.



muebles polivalentes

para aulas actuales

multipurpose furniture

for modern school

des meubles polyvalents

pour des salles actuelles

mobles polivalentes

per a aules actuals



SILLAS | CHAIRS | CHAISES | CADIRES



SOFÁS | SOFAS | CANAPÉS | SOFÀS



MESAS | TABLES | TABLES | TAULES



ARMARIOS | CABINETS | BIBLIOTHÈQUE | ARMARIS



COMPLEMENTOS | COMPLEMENTS | COMPLEMENTS | COMPLEMENTS



MIA



MIA BASIC



MIA CANTILEVER



MIA CASTORS



MIA MINI LIFT



MIA LIFT



MIA BIG LIFT



MIA STOOL



MIA TABLE



Asiento dinámico
Dynamic sitting
Asise dynamique
Seient dinàmic



MIA BASIC

Ref. 1028



Silla con respaldo curvado para un óptimo confort. Asiento dinámico y saludable. Estructura metálica. Fácil de apilar, ligera y resistente. Fácil de limpiar. Opción de asiento tapizado.

Waterfall seat chair. Comfortable design. Dynamic sitting. Metal frame. Stackable, lightweight and durable. Easy clean up. Upholstered seat option.

Chaise avec dossier courbé pour assurer un excellent confort. Assise dynamique. Structure métallique. Empilable, légère et durable. Facile à nettoyer. Option assise rembourée.

Cadira amb respalller corbat per a un òptim confort. Seient dinàmic i saludable. Estructura metàl·lica. Fàcil d'apilar, lleugera i resistent. Fàcil de netejar. Opció seient tapissat.



TALLA | SIZE | TAILLE | TALLA (+info P. 135)



MIA CANTILEVER

Ref. 1027



Silla con respaldo curvado para un óptimo confort. Asiento dinámico y saludable. Estructura metálica. Robusta y resistente. Estabilidad excepcional. Fácil de limpiar. Opción de asiento tapizado.

Waterfall seat chair. Comfortable design. Dynamic sitting. Metal frame. Durable. Extremely stable. Easy clean up. Upholstered seat option.

Chaise avec dossier courbé pour assurer un excellent confort. Dynamique. Structure métallique. Robuste et durable. Facile à nettoyer. Option assise rembourée.

Cadira amb respalller corbat per a un òptim confort. Seient dinàmic i saludable. Estructura metàl·lica. Robusta i resistent. Estabilitat excepcional. Fàcil de netejar. Opció seient tapissat.



TALLA | SIZE | TAILLE | TALLA (+info P. 135)



MIA CASTORS

Ref. 1029



TALLA | SIZE | TAILLE | TALLA (+info P. 135)



Silla con respaldo curvado para un óptimo confort. Asiento dinámico y saludable. Estructura metálica. Gran movilidad y versátil. Ágil y silenciosa. Opción de asiento tapizado.



Waterfall seat chair. Comfortable design. Dynamic sitting. Metal frame. Great mobility and versatile. Agile and noiseless. Upholstered seat option.



Chaise avec dossier courbé pour assurer un excellent confort. Dynamique. Structure métallique. Grande mobilité et multifonction. Agile et silencieuse. Option assise rembourée.



Cadira amb respalller corbat per a un òptim confort. Seient dinàmic i saludable. Estructura metàl·lica. Gran mobilitat i versàtil. Àgil i silenciosa. Opció seient tapissat.



MIA MINI LIFT

Ref. 169



TALLA | SIZE | TAILLE | TALLA (+info P. 135)



Silla giratoria con respaldo curvado para un óptimo confort. Uso infantil con pistón de gas regulable en altura. Base de polipropileno en forma de estrella con ruedas. Gran movilidad y versátil.

Swivel waterfall seat chair. Comfortable design. Kids' use with stroke gas lift and adjustable weight. Polypropylene 5 stars base. Great mobility and versatile.



Chaise pivotante avec assise courbé pour assurer un excellent confort. Vérin à gaz réglable en hauteur spéciale pour enfants. Piètement en polypropylène 5 branches sur roulettes. Grande mobilité et multifonction.



Cadira giratòria amb respalller corbat per a un òptim confort. Ús infantil amb pistó de gas regulable en altura. Base de polipropilè en forma d'estrella amb rodes. Gran mobilitat i versàtil.



MIA LIFT

Ref. 1035



TALLA | SIZE | TAILLE | TALLA (+info P. 135)

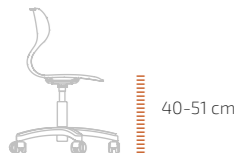

40-51 cm



Silla giratoria con respaldo curvado para un óptimo confort. Pistón de gas regulable en altura. Base de polipropileno en forma de estrella con ruedas. Uso diario y facilidad de combinaciones. Opción de asiento tapizado.

Swivel waterfall seat chair. Comfortable design. Stroke gas lift and adjustable weight. Polypropylene 5 stars base. Great mobility and versatile. Daily use. Upholstered seat option.

Chaise pivotante avec dossier courbé pour assurer un excellent confort. Vérin à gaz réglable en hauteur. Piètement en polypropylène 5 branches sur roulettes. Grande mobilité et multifonction. Option assise rembourée.

Cadira giratòria amb respalller corbat per a un òptim confort. Pistó de gas regulable en altura. Base de polipropilè en forma d'estrella amb rodes. Ús diari i facilitat de combinacions. Opció seient tapissat.



MIA BIG LIFT

Ref. 1039



TALLA | SIZE | TAILLE | TALLA (+info P. 135)



40-51 cm

Silla giratoria con asiento kingsize para un óptimo confort. Pistón de gas regulable en altura. Base de polipropileno en forma de estrella con ruedas. Uso diario y facilidad de combinaciones. Opción de asiento tapizado.

Kingsize swivel waterfall seat chair. Comfortable design. Stroke gas lift and adjustable weight. Polypropylene 5 stars base. Great mobility and versatile. Daily use. Upholstered seat option.

Chaise pivotante avec un grand dossier courbé pour assurer un excellent confort. Vérin à gaz réglable en hauteur. Piètement en polypropylène 5 branches sur roulettes. Grande mobilité et multifonction Usage quotidien. Option assise rembourée.

Cadira giratòria amb seient kingsize d'òptim confort. Pistó de gas regulable en altura. Base de polipropilè en forma d'estrella amb rodes. Ús diari i facilitat de combinacions. Opció seient tapissat.



MIA LIFT

MIA BIG LIFT

MIA STOOL

Ref. 1030



TALLA | SIZE | TAILLE | TALLA (+info P. 135)

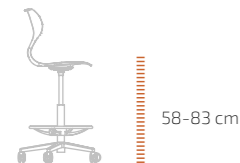

Taburete alto con respaldo curvado y adaptable para un óptimo confort. Pistón de gas regulable en altura y base de poliuretano con ruedas. Anillo de aluminio reposapiés ajustable. Multifuncional y dinámico. Opción de asiento tapizado.

High waterfall seat stool. Comfortable design. Stroke gas lift and adjustable weight. Polypropylene base with castors. Aluminium ring with adjustable footrest. Dynamic and multipurpose sitting. Upholstered seat option.

Tabouret haut avec dossier courbé pour assurer un excellent confort. Vérin à gaz réglable en hauteur. Piètement en polypropylène sur roulettes. Repose-pied rond réglable en aluminium. Dynamique et multifonction. Option assise rembourée.

Tamboret alt amb respalller corbat i adaptable per a un òptim confort. Pistó de gas regulable en altura i base de poliuretà amb rodes. Anell d'alumini reposapeus ajustable. Multifuncional i dinàmic. Opció seient tapissat.



MIA TABLE

Ref. 1036



TALLA | SIZE | TAILLE | TALLA (+info P. 135)

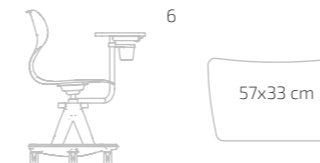

Silla giratoria con respaldo curvado para un óptimo confort. Mesa abatible de polipropileno y giratoria 360°. Soporte para bebidas y bandeja en la parte inferior. Versátil y resistente.

Swivel waterfall seat. Comfortable design. 360° polypropylene folding table. Drink holder. Lower tray. Durable and versatile.

Chaise pivotante avec dossier pour assurer un excellent confort. Tablette pliante et pivotante sur 360° avec porte-gobelet. Plateau au dessous. Durable et multifonction.

Cadira giratòria amb respalller curvat per a un òptim confort. Taula abatible de polipropilè i giratòria 360°. Suport per a begudes i safata a la part inferior. Versàtil i resistent.





MIA TABLE



¿Cómo funciona? Mira el vídeo aquí:
How does it work? Watch the video here:
Comment ça fonctionne ? Regarde la vidéo ici:
Com funciona? Mira el video aquí:

YouTube



LANCE

Ref. 1021

Nuestro taburete Lance con base redondeada favorece una postura e inclinación más cómoda. Ligero y regulable en altura permite que sea ideal para aulas, espacios polivalentes, co-workings y bibliotecas

Notre tabouret Lance avec base arrondie favorise une position et inclinaison plus confortables. Léger et réglable en hauteur il est idéal pour les salles, espaces polyvalents, de co-working et bibliothèques.

Our Lance stool with its rounded base stimulates good posture and a more comfortable inclination angle. Light and height adjustable makes it ideal for classrooms, multipurpose areas, co-working and libraries.

El nostre tamburet Lance amb base arrodonida afavoreix una postura i inclinació més còmode. Lleuger i regulable en alçada permet que sigui ideals per aules, espais polivalents, de co-working i biblioteques.

TALLA | SIZE | TAILLE | TALLA (+info P.135)

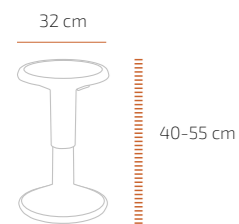

Asiento dinámico
Dynamic sitting
Asise dynamique
Seient dinàmic



ZTOOL ● ● ●

Ref. 1020



Nuevo invento que te permite trabajar de una forma cómoda con el portátil o la libreta, en el suelo, en una silla, en el sofá, etc. Ideal para potenciar el trabajo cooperativo o individual y las aulas de inteligencias múltiples.

A new invention that allows you to work comfortably with the laptop or the notebook on the floor, on a chair, on the sofa... It is ideal to enhance cooperative learning classes. You can use it in team or individually.

Nouvelle invention qui permet de travailler d'une façon confortable, avec la tablette ou cahier, au sol, sur une chaise, un sofa etc... Idéal pour maximiser le travail coopératif ou individuel et les classes d'intelligences multiples.

Nou invent que et permet treballar d'una forma còmode amb el portàtil o llibreta, al terra, a una cadira, al sofà, etc. Ideal per potenciar el treball cooperatiu o individual i les aules d'intelligències múltiples.

¿Cómo funciona? Mira el vídeo aquí:

How does it work? Watch the video here:

Comment ça fonctionne ? Regarde la vidéo ici:

Com funciona? Mira el video aquí:

YouTube



Mesa de trabajo portátil
Portable work surface
Table de travail portable
Taula de treball portàtil



ZTOOL TROLLEY

Ref. 1037

Capacidad 40 ztool
Capacity 40 ztool
Capacité 40 ztool
Capacitat 40 ztool



LUCA



Ref. 167-1 / 167-2 / 167-3 / 167-4

Silla ergonómica infantil monobloque de polipropileno. Ligera y fácil de apilar. Estructura antivuelco. Multiusos interior y exterior.

Kids' ergonomic chair. Monobloc made by polypropylene. Lightweight design. Stackable. Anti-tip structure. Multipurpose indoor & outdoor.

Chaise enfant ergonomique multi-usages. Polypropylène moulé. Légère et empilable. Grande stabilité. Intérieur et extérieur.

Cadira ergonòmica infantil monobloc de polipropilè. Gran estabilitat. Lleugera i fàcil d'apilar. Multifuncional interior i exterior.

Ligera y resistente
Light and durable
Légère et durable
Lleugera i resistent



TALLA | SIZE | TAILLE | TALLA (+info P. 135)



LUCA

Ref. 167-5 / 167-6

Silla ergonómica monobloque de polipropileno. Ligera y fácil de limpiar. Estructura antivuelco y fácil de apilar. Multiusos interior y exterior.

Kids' ergonomic chair. Monobloc made by polypropylene. Lightweight design. Easy clean up. Stackable. Anti-tip frame. Multipurpose indoor & outdoor.

Chaise enfant ergonomique multi-usage. Polypropylène moulé. Légère et empilable. Facile à nettoyer. Grande stabilité. Intérieur et extérieur.

Cadira ergonòmica infantil monobloc de polipropilè. Gran estabilitat. Lleugera i fàcil d'apilar. Multifuncional interior i exterior.

Ligera y resistente
Light and durable
Légère et durable
Lleugera i resistent



TALLA | SIZE | TAILLE | TALLA (+info P. 135)



Photo by Silva (Photopoint)

CHLOE



Butaca confortable giratoria de respaldo tapizada en poli-piel de PVC. Estructura interior metálica. Espuma de alta densidad de rápida recuperación. Retardante al fuego.

Swivel comfortable armchair upholstered in foam and PVC. Metal structure. Injected polyurethane. Aluminium 4 star base. Fire retardant.

Fauteuil confortable pivotant en similicuir de PVC retardant au feu. Structure métallique. Polyuréthane injecté. Base étoile 4 branches en aluminium.

Butaca comfortable giratòria amb respall tapissada en polipell de PVC. Estructura interior metàl·lica. Escuma d'alta densitat de ràpida recuperació. Retardant al foc.

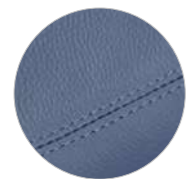

69 cm



67 cm



79 cm

44 cm



Ergonómica
Ergonomic
Ergonomique
Ergonòmica



CHARLOTTE



Ref. 1041

Butaca comfortable giratoria kingsize de respaldo alto tapizada en poli-piel de PVC. Estructura interior metálica. Espuma de alta densidad y rápida recuperación. Retardante al fuego.

Comfortable kingsize swivel armchair, high backrest, upholstered in foam and PVC. Metal structure. Injected polyurethane. Aluminium 4 star base. Fire retardant.

Fauteuil confortable pivotant avec grand dossier en similicuir de PVC retardant au feu. Structure métallique. Polyuréthane injecté. Base étoile 4 branches en aluminium.

Butaca comfortable giratòria kingsize amb respallter alt tapissada en polipell de PVC. Estructura interior metàl·lica. Escuma d'alta densitat de ràpida recuperació. Retardant al foc.



Reflexión y confort
Reflection and comfort
Réflection et confort
Reflexió i confort

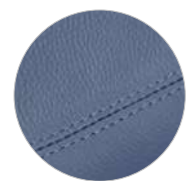

82 cm

77 cm

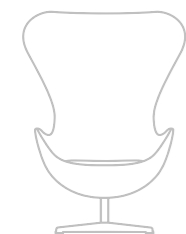

108 cm



42 cm



SOFAS

ANGLE ● ●

Ref. 12001



CUBE ● ●

Ref. 12002



TUBE ● ●

Ref. 12003

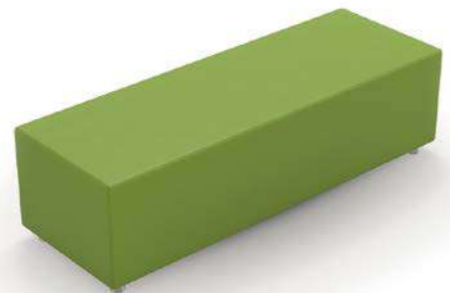

COMPLETE SOFA ● ●

Ref. 12005

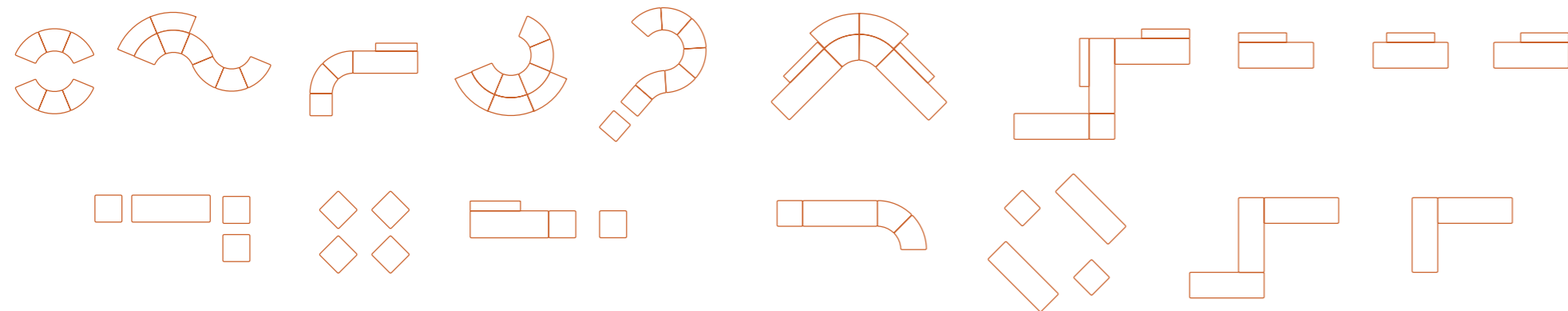
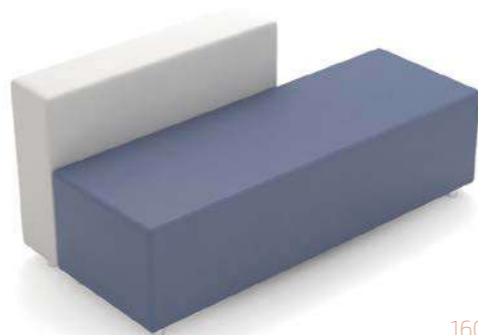

Sofá ideal para crear espacios de reflexión, creatividad y trabajo cooperativo, aprovechando rincones del aula y pasillos que no están en uso. Modular y ligero tapizado en poli-piel de PVC, retardante al fuego. Estructura interior de madera. Espuma de alta densidad y rápida recuperación.

Ideal sofa to create spaces of reflexion, creativity and cooperative learning classes, taking advantage of the corners of the classrooms and corridors when not in use. Light and modular. Upholstered in PVC vinyl. Wooden frame. High density foam.

Sofá idéal pour créer des espaces de réflexion, créativité et apprentissage coopératif en utilisant les coins des salles de classe ou les couloirs. Modulable et léger, en forme d'angle, tapissé en cuir synthétique PVC résistant au feu. Structure en bois. Mousse d'haute densité.

Sofà ideal per a crear espais de reflexió, creativitat i treball cooperatiu, aprofitant els racons de l'aula i passadissos que no estan en ús. Modular i lleuger tapissat en polipell de PVC, retardant al foc. Estructura interior de fusta. Escuma d'alta densitat i ràpida recuperació.

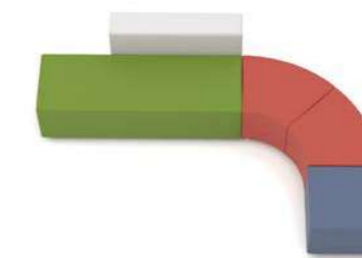
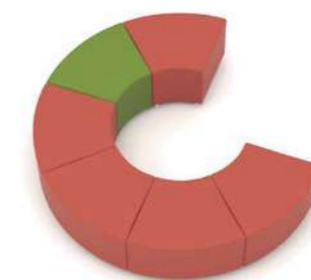

MOVE

Ref. 1605

Grada modular móvil que te permite crear diferentes espacios de aprendizaje y dividir áreas. Ideal para el trabajo en grupo y para mejorar la interacción entre los alumnos. Ruedas, estructura de madera, capacidad de almacenaje y tapizado de PVC.

Gradin modulaire mobile permettant de créer des différents espaces d'apprentissage et de diviser des espaces. Idéal pour le travail de groupe et pour améliorer l'interaction entre les étudiants. Roulettes, structure en bois, espaces de rangement et tapisserie en PVC.

Mobile and modular grade that allows you to create different learning spaces and divide zones. Ideal to work in groups and to improve the interaction among children. Castors, wooden frame, storage capacity and upholstered in PVC.

Grada modular mòbil que et permet crear diferents espais d'aprenentatge i dividir zones. Ideal per a treballar en grup i millorar la interacció entre els alumnes. Rodes, estructura de fusta, capacitat de magatzematge i tapissat PVC.

Múltiples combinaciones para una buena organización del espacio
 Many combinations for an excellent space organization
 Plusieurs combinaisons pour une bonne organisation de l'espace
 Múltiples combinacions per a una bona organització de l'espai

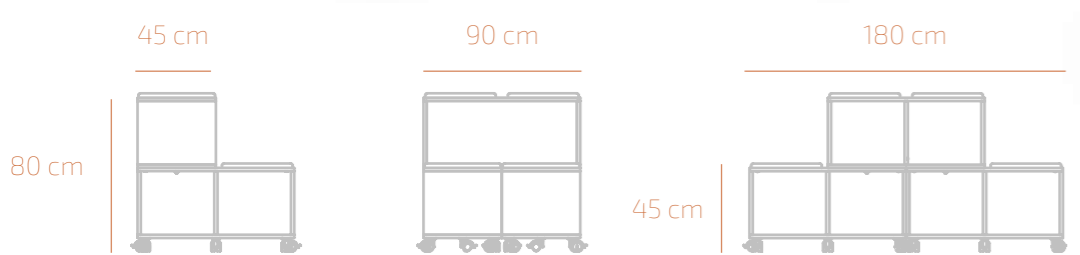

¿Cómo funciona? Mira el vídeo aquí:

How does it work? Watch the video here:

Comment ça fonctionne ? Regarde la vidéo ici:

Com funciona? Mira el video aquí:

YouTube



LOUISE

Ref. 2354

Mesa multiusos modular con base de estrella con 4 pies de aluminio. Ajustable en altura a través del pistón de gas.

Table multifonctions avec piètement 4 branches aluminium. Vérin à gaz réglable en hauteur.

Multipurpose table with star base and 4 aluminum legs. Adjustable height through a stroke gas lift.

Taula multiusos i modular amb base d'estrella amb 4 peus d'alumini. Ajustable en alçada mitjançant pistó de gas.



H 70 cm

H 47 cm

Simple y ligera
Simple and light
Simple et légère
Simple i lleugera

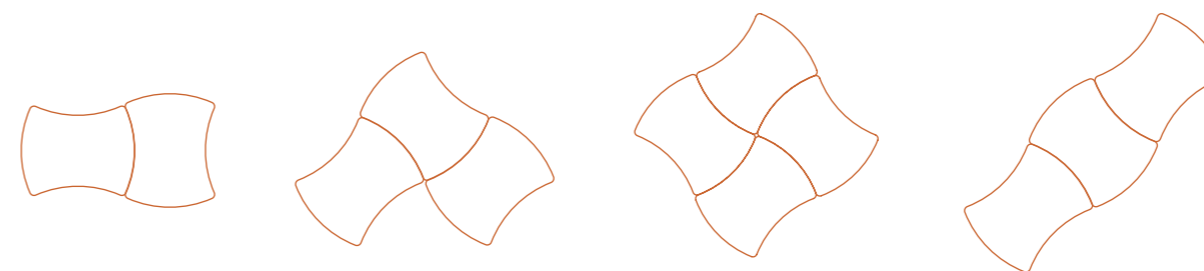

Mesas de aprendizaje significativo y activo

Tables of meaningful and active learning

Tables d'apprentissage significatif et actif

Taules d'aprenentatge significatiu i actiu

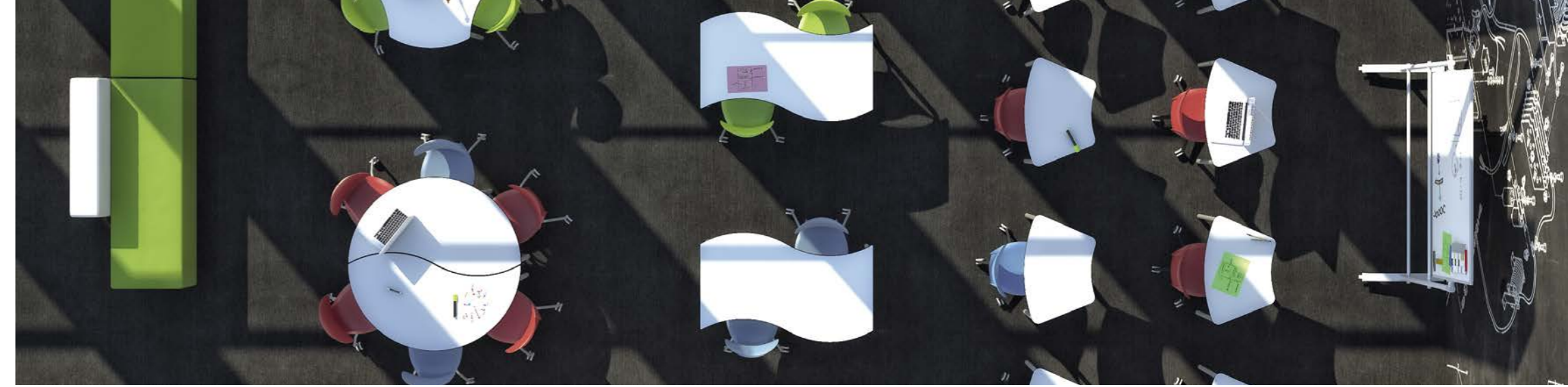

square



arrow



hexa

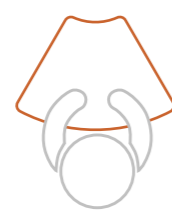

octa



yang



wave

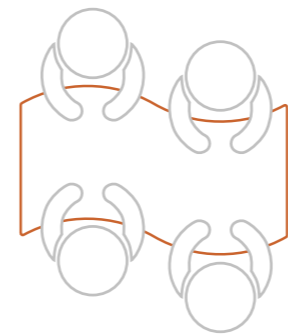

trix

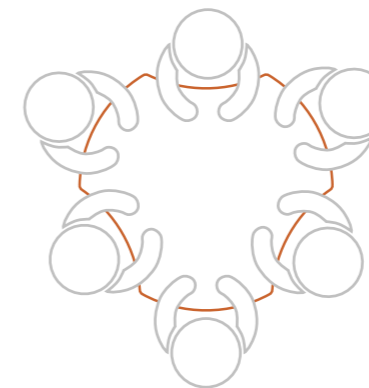

rectangle

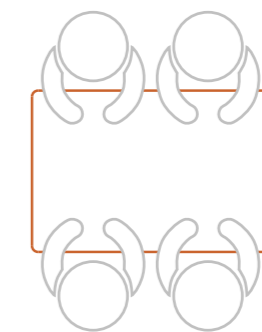

rectangle plus

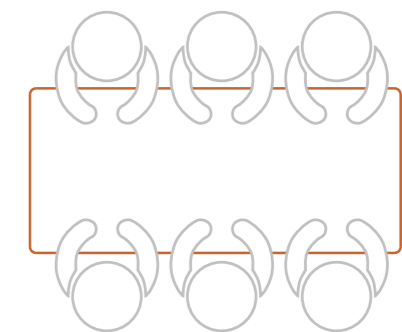

Mesas polivalentes

Aulas actuales, espacios amplios y generosos



Multipurpose tables

Modern schools, wide and generous spaces.



Tables polyvalents

Salles actuelles, des espaces généreux.

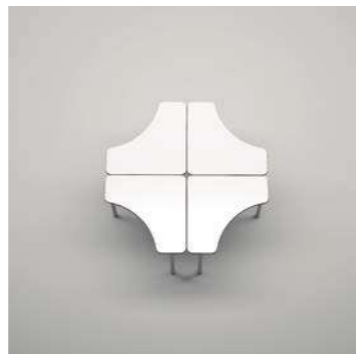

Taules polivalentes

Aules actuals, espais amplis i generosos



DEBATIR
TO DISCUSS
DÉBATER
DEBATRE



EVALUAR
TO ASSESS
ÉVALUER
AVALUAR



APRENDER
TO LEARN
APPRENDRE
APRENDRE



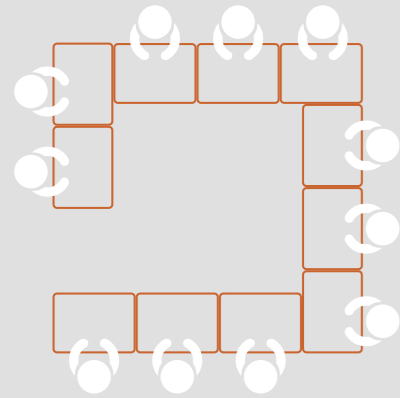
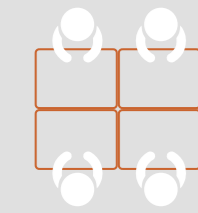
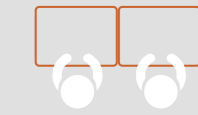
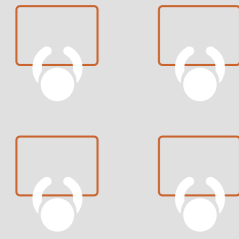

SQUARE

Ref. 2341R



TALLA | SIZE | TAILLE | TALLA (+info P.135)



ARROW

Ref. 2329R



TALLA | SIZE | TAILLE | TALLA (+info P.135)



¿Cómo funciona? Mira el vídeo aquí:
How does it work? Watch the video here:
Comment ça fonctionne ? Regarde la vidéo ici:
Com funciona? Mira el vídeo aquí:

YouTube

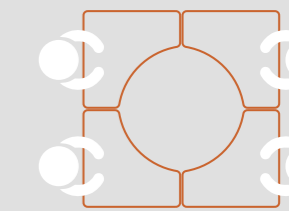
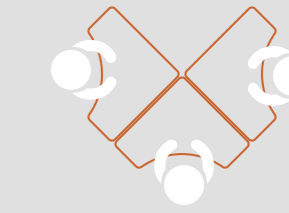
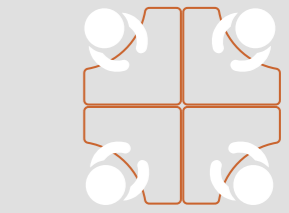
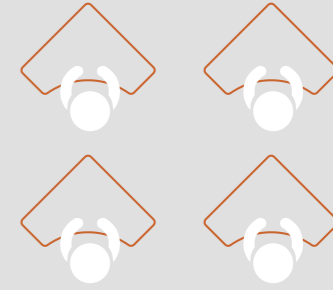

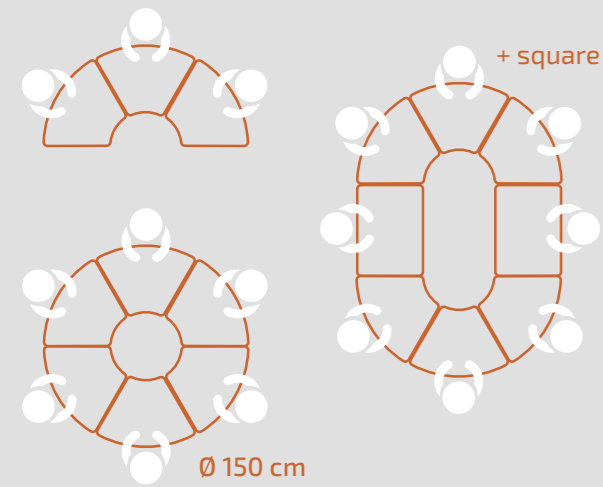

HEXA

Ref. 2336R



¿Cómo funciona? Mira el video aquí:
How does it work? Watch the video here:
Comment ça fonctionne ? Regarde la vidéo ici:
Com funciona? Mira el video aquí:

YouTube



TALLA | SIZE | TAILLE | TALLA (+info P.135)



OCTA

Ref. 2335R

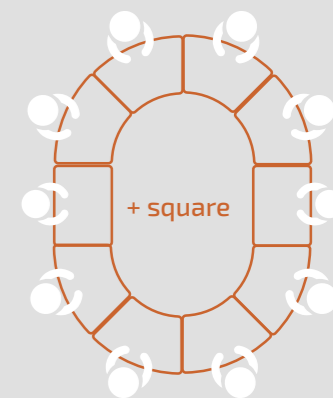
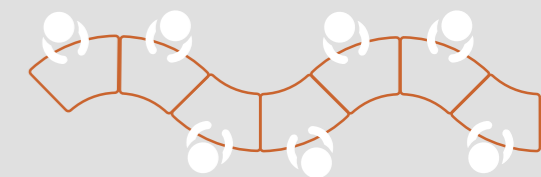
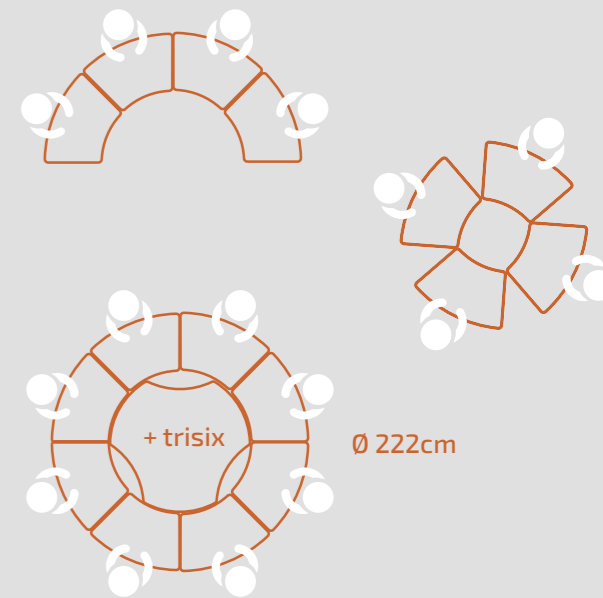

TALLA | SIZE | TAILLE | TALLA (+info P.135)

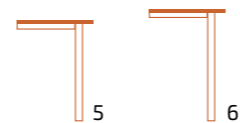

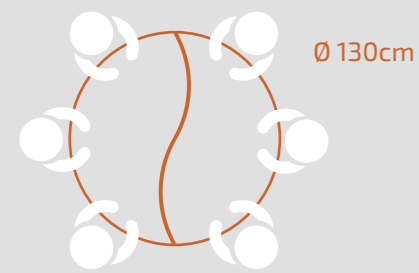

Ø 130cm

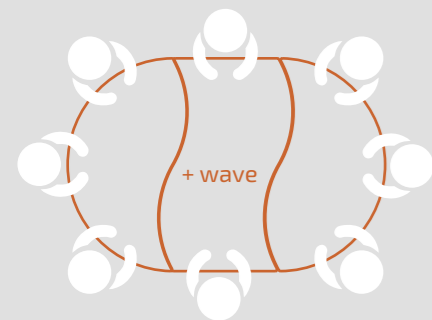

+ wave

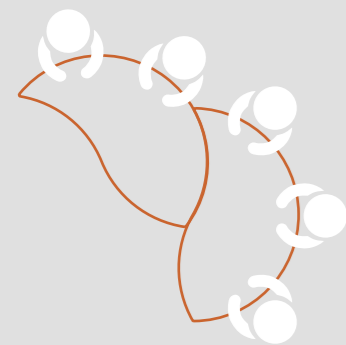

YANG

1-3 > Ref. 2345RC
4-6 > Ref. 2345R



1-3



4-6



TALLA | SIZE | TAILLE | TALLA (+info P. 135)

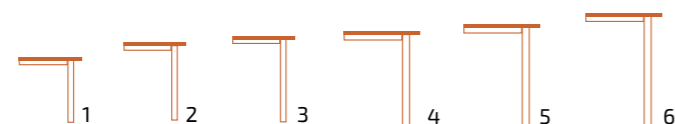

Ø130x73 cm

WAVE

1-3 > Ref. 2344RC
4-6 > Ref. 2344R



1-3



4-6



TALLA | SIZE | TAILLE | TALLA (+info P. 135)

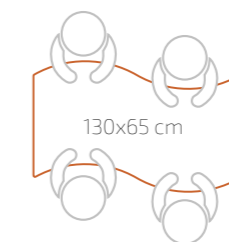
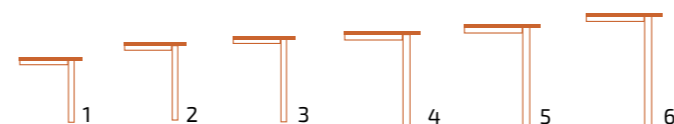

130x65 cm

TRISIX

1-3 > Ref. 2346RC
4-6 > Ref. 2346R



1-3



4-6



TALLA | SIZE | TAILLE | TALLA (+info P. 135)

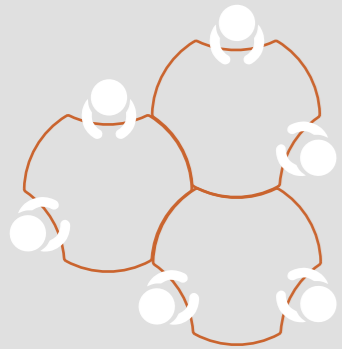
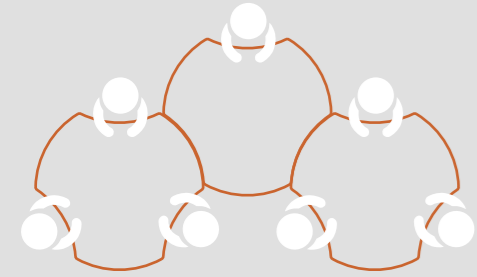
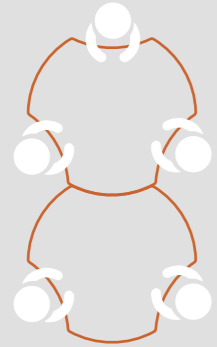
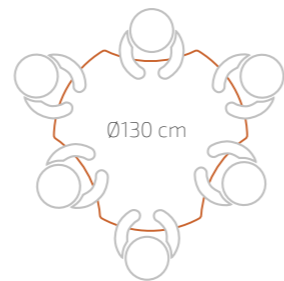
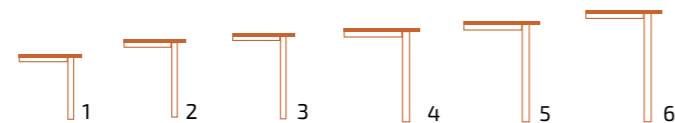

RECTANGLE

1-3 > Ref. 2352-3
4-6 > Ref. 2352-6



1-3



4-6



* *OPTIONAL*

*

Cajón metálico
Metal drawer
Tiroir métallique
Calaix metàllic

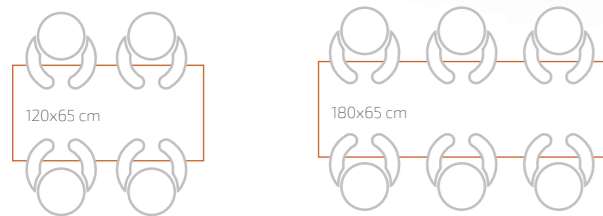

TALLA | SIZE | TAILLE | TALLA (+info P. 135)

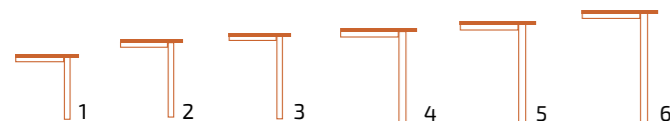

RECTANGLE PLUS

Ref. 2353-8

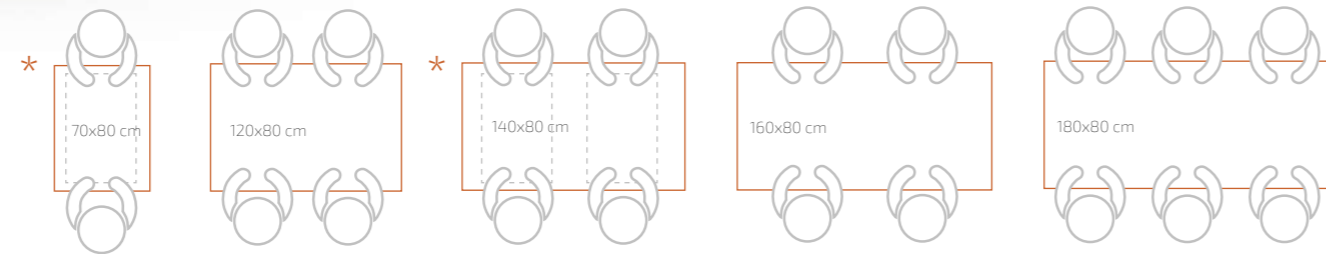

TALLA | SIZE | TAILLE | TALLA (+info P. 135)



TALLA | SIZE | TAILLE | TALLA (+info P. 135)

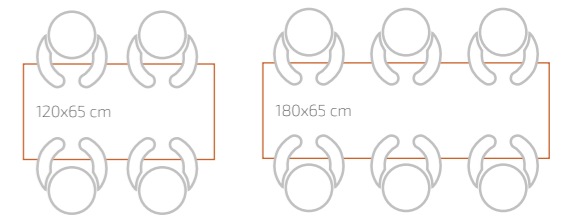

RECTANGLE TEACHER

Ref. 2355D



Faldón metálico
Metalic courtesy panel
Voile de fond métallique
Faldó metàl·lic



TALLA | SIZE | TAILLE | TALLA (+info P. 135)



120x65 cm



RECTANGLE
RECTANGLE TEACHER
RECTANGLE PLUS

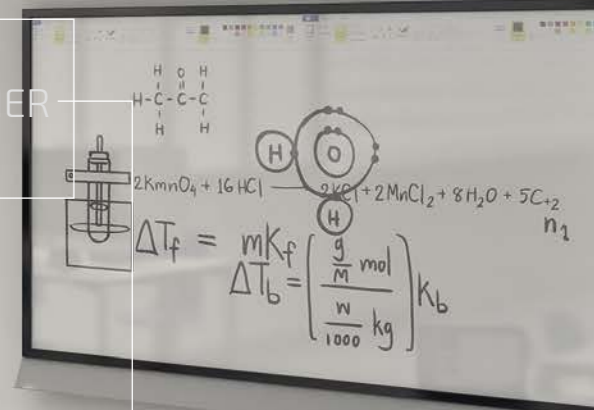

NAXEL

Ref. 620



TALLA | SIZE | TAILLE | TALLA (+info P. 135)

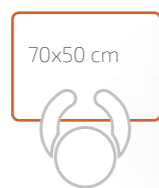
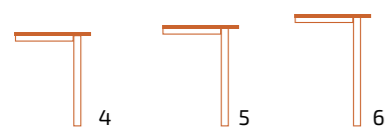

Diseño ergonómico, resistente y actual
Ergonomic, durable and modern design
Design ergonomique, résistant et actuel
Disseny ergonòmic, resistent i actual



SPACE

Ref. 260



Mesa versátil de gran funcionalidad y resistencia
 Versatile table with a great functionality and durable
 Table multifonctions de haute fonctionnalité et résistance
 Taula versàtil de gran funcionalitat i resistència



TALLA | SIZE | TAILLE | TALLA (+info P. 135)

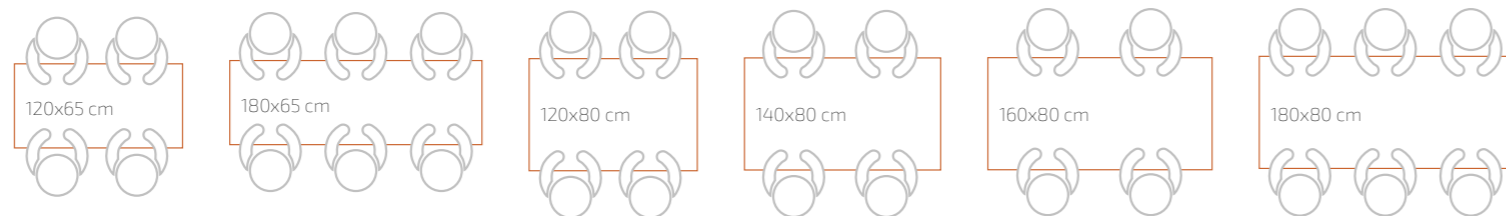
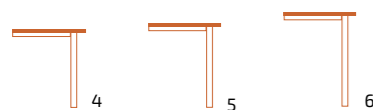

SPACE PLUS

Ref. 260



TALLA | SIZE | TAILLE | TALLA (+info P. 135)

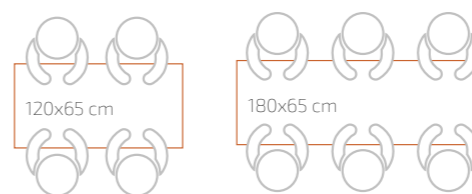

RONY

Ref. 2221



Mesa versàtil con patas regulables
Versatile table with high adjustable legs
Table multifonctions avec pieds réglables en hauteur
Taula versàtil amb potes regulables

Ref. 2220



TALLA | SIZE | TAILLE | TALLA (+info P. 135)

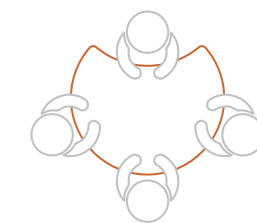
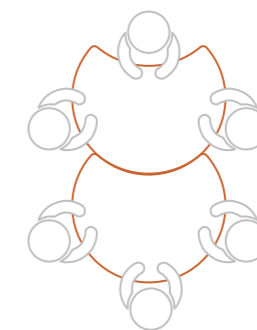
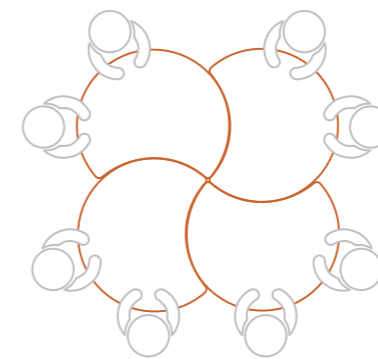
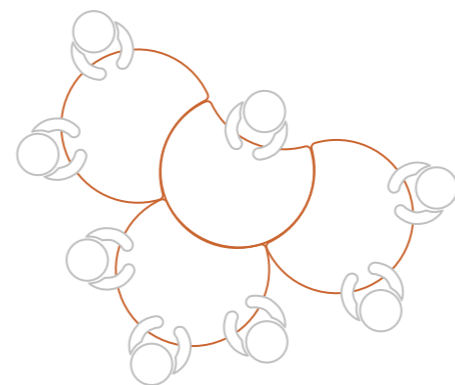
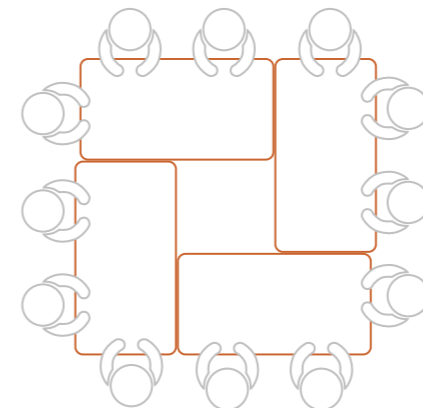
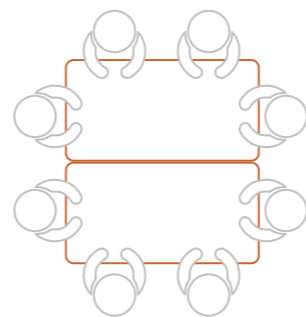
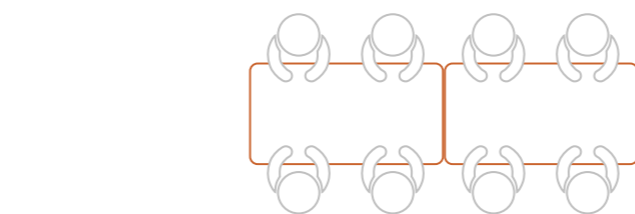
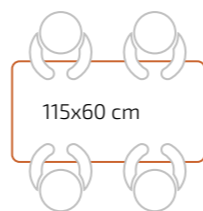
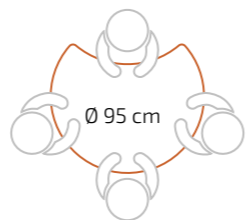
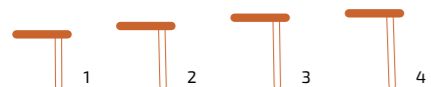

ALUFLOOP

Ref. 2048R

Mesa abatible que garantiza un uso inteligente del espacio para potenciar el aprendizaje. Ágil y polivalente permitiendo crear diversos escenarios y actividades de forma continua.

Table pliante permettant une utilisation intelligente de l'espace pour stimuler l'apprentissage. Agile et polyvalente, permettant de créer divers scénarios et activités en continu.

Foldable table that guarantees a smart use of the space to develop learning. Agile and multi-use. It creates different spaces and activities continuously.

Taula abatible que garantiza un ús intel·ligent de l'espai per a potenciar l'aprenentatge. Àgil i polivalent, permetent crear diferents escenaris i activitats de forma continua.

Mesa abatible y ágil
Foldable and agile table
Table pliante et agile
Taula abatible i àgil



TALLA | SIZE | TAILLE | TALLA (+info P. 135)

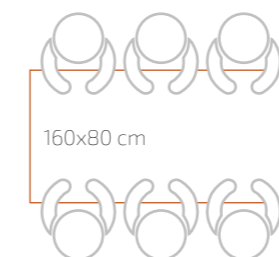
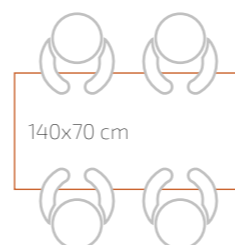

MINIFLOOP

Ref. 2261DNR

Mesa abatible infantil que garantiza un uso inteligente del espacio para potenciar el aprendizaje. Ágil y polivalente. Permite diferentes modos de trabajo en el aula para crear y experimentar, ofreciendo múltiples funciones.

Children's folding table that guarantees a smart use of the space to develop learning. Agile and multi-use. It creates different spaces and activities to create and experiment, providing multipurpose functions.

Table pliante pour enfant permettant une utilisation intelligente de l'espace pour stimuler l'apprentissage. Agile et polyvalente, permettant de différentes façons de travailler en classe pour créer et expérimenter en offrant multiples fonctions.

Taula abatible infantil que garantitza un ús intel·ligent de l'espai per a potenciar l'aprenentatge. Àgil i polivalent. Permet diferents modes de treball a l'aula per a crear i experimentar, oferint múltiples funcions.



Mesa infantil abatible y ágil
Foldable and agile primary table
Table pour enfants pliante et agile
Taula infantil abatible i àgil



TALLA | SIZE | TAILLE | TALLA (+info P. 135)

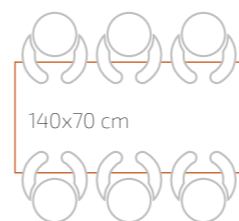

Armarios

Bookcase

Armoire

Armaris



H 80cm



MARIE
Ref. 732-601



HEDY
Ref. 532-501



ADA
Ref. 532-502



JANE
Ref. 632-504



MERIT
Ref. 632-507



GRACE
Ref. 632-501

H 120cm



IRENE
Ref. 533-501



EMMY
Ref. 533-502



ANNIE
Ref. 633-507



SOPHIE
Ref. 633-501

H 160cm



MILEVA
Ref. 534-501



FLORA
Ref. 534-508



INGE
Ref. 534-509



ELSA
Ref. 634-508



ALICE
Ref. 634-510

H 200cm



EMILIE
Ref. 535-501



MAUD
Ref. 535-508



ROSIE
Ref. 535-521

H 80cm



H 120cm

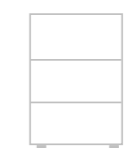

H 160cm



H 200cm



MARIE

Ref. 732-601

H 80cm



Armario curvo con ruedas opcionales. Dinámico y flexible. Ideal para definir diferentes zonas. Modular y combinable con nuestra gama de sofás.

Curved bookcase with castors set available. Dynamic and flexible. Ideal to define different spaces. Modular and mixable with our sofa's range.

Armoire bibliothèque courbé avec roulettes optionelles. Dynamique et flexible. Idéal pour définir différents zones. Modulaire et combinable avec notre gamme de canapés.

Armari llibreter corbat amb rodes opcionals. Dinàmic i flexible. Ideal per a definir diferents zones. Modular i combinable amb la nostra gama de sofàs.

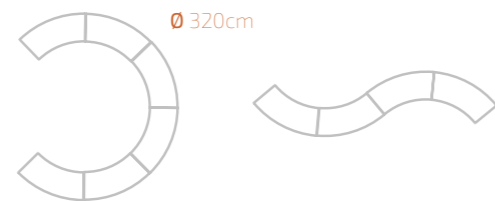
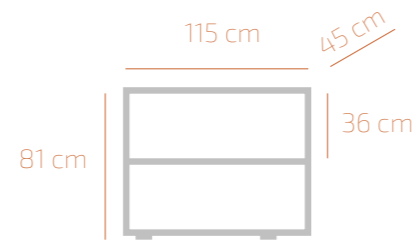

HEDY

Ref. 532-501

H 80cm

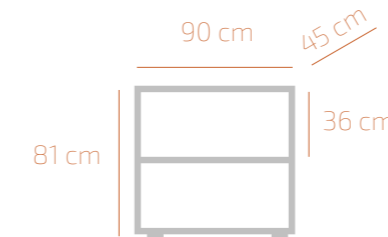

ADA

Ref. 532-502

H 80cm

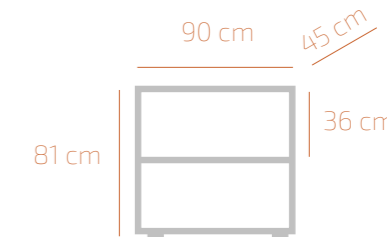

JANE

Ref. 632-504

H 80cm

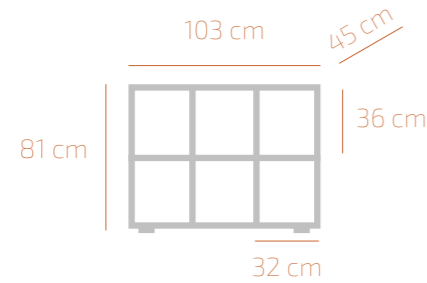

MERIT

Ref. 632-507

H 80cm



7cm

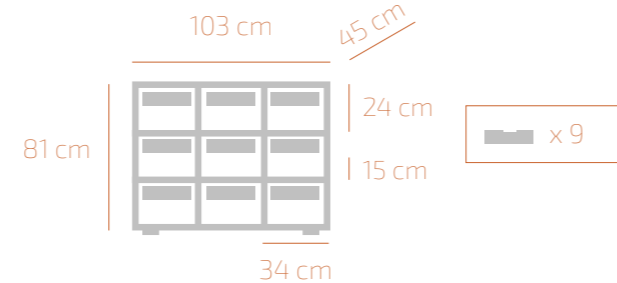

GRACE

Ref. 632-501

H 80cm



7cm

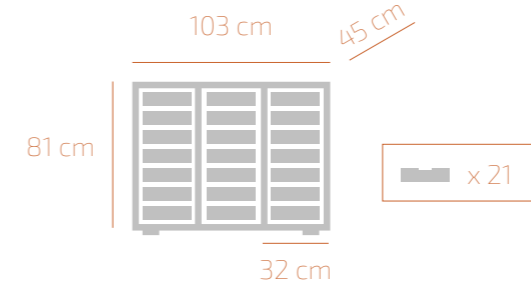

15cm

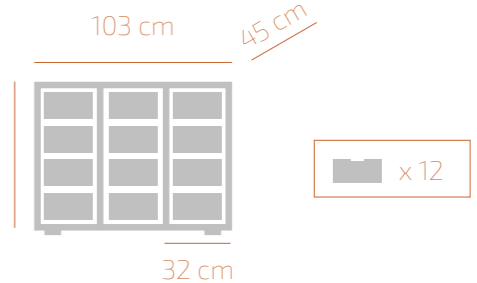

IRENE

Ref. 533-501

H 120 cm

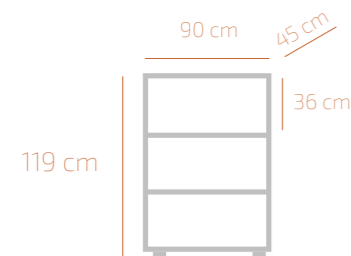

EMMY

Ref. 533-502

H 120 cm

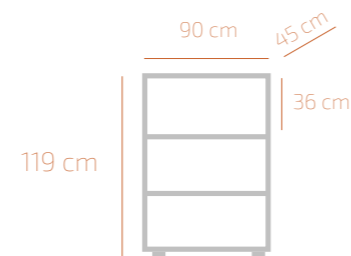

ANNIE

Ref. 633-507

H 120 cm

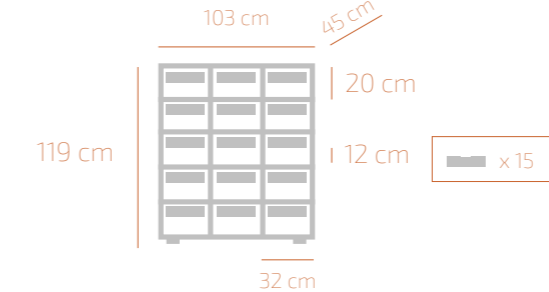

SOPHIE

Ref. 633-501

H 120 cm

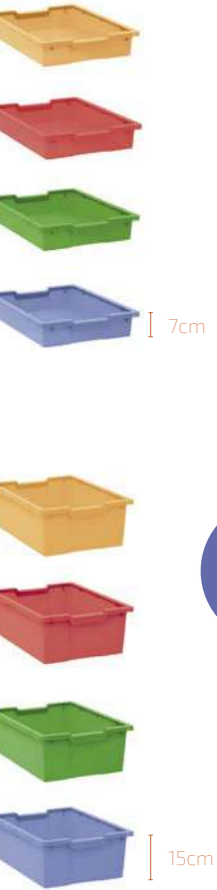

MILEVA

Ref. 534-501

H 160 cm

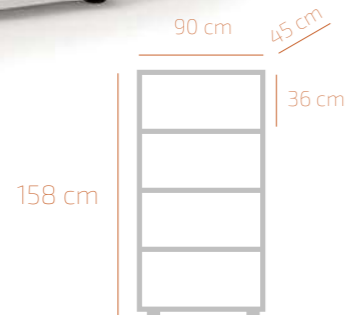

FLORA

Ref. 534-508

H 160 cm

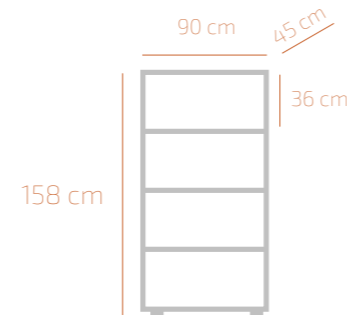

INGE

Ref. 534-509

H 160 cm

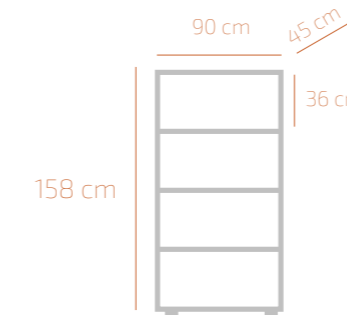

ELSA

Ref. 634-508

H 160 cm

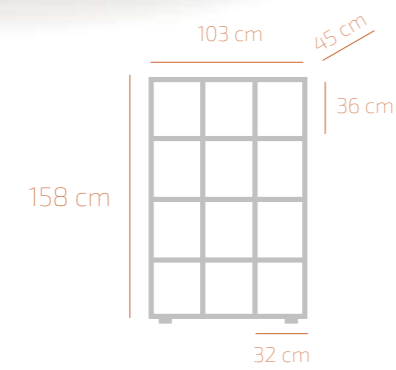

ALICE

Ref. 634-510

H 160 cm

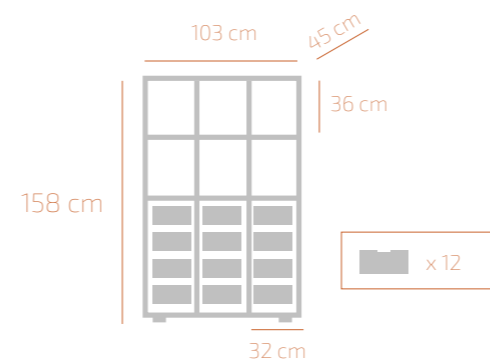
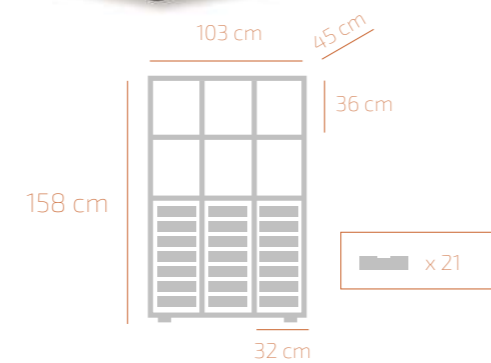

EMILIE

Ref. 535-501

H 200 cm

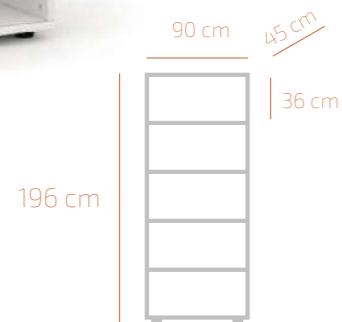

MAUD

Ref. 535-508

H 200 cm

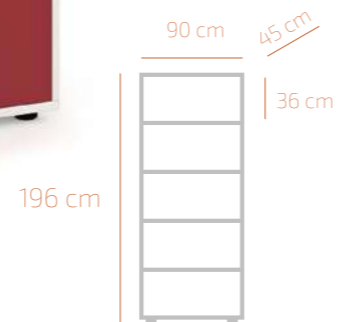

ROSIE

Ref. 535-521

H 200 cm

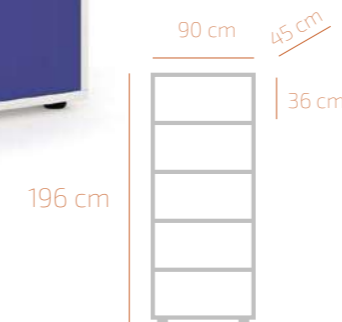

DAN

Ref. 551



Funcional y duradero
Useful and durable
Fonctionnel et durable
Funcional i durable

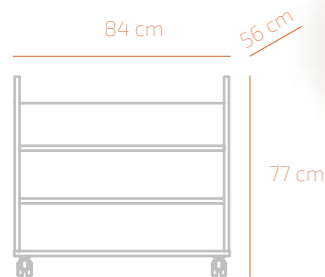

Mueble diseñado para libros o juegos educativos con ruedas y frenos. Tiene laterales de varios colores, a escoger. Es ideal para complementar clases de guardería, educación infantil y bibliotecas.

Furniture for books or educational games with castors and brakes. Side panels with different color to choose. Complementary furniture for nursery, primary school and library.

Chariot à livres avec 6 cases, double étagère et 3 compartiments. Coloris des latéraux au choix et roulettes avec freins. Meuble complémentaire pour crèches, écoles maternelles, écoles primaires et bibliothèques.

Moble dissenyat per a llibres o jocs educatius amb rodes i fre. Té laterals de diversos colors a escollir. Ideal per a complementar classes d'escola bressol, educació infantil i biblioteques.



MARCUS

Ref. 7028

Perchero de metal con 5 ganchos. Ideal para equipar las clases de escuelas de primaria, secundaria y universidades. Resistente y antivandálico.

Metal coat rack panel with 5 metal double hooks. Ideal to equip the primary schools, colleges and universities. Resistant and vandalproof.

Porte-manteaux mural scolaire résistant et économique avec 5 crochets doubles métalliques. Idéal pour équiper les classes des écoles primaires, secondaires et universitaires. Anti-vandalisme.

Penja-robes de metall amb 5 ganxos. Ideal per a equipar les classes d'escoles de primària, secundària i universitats. Resistents i antivandàlics.

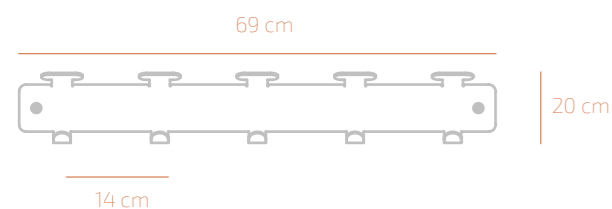

PEGGY

Ref. 751

Perchero de madera con 5 ganchos dobles de plástico de varios colores. Ideal para equipar las clases de guarderías, escuelas de educación infantil y primaria.

Wooden coat rack panel with 5 colored double plastic hooks. Ideal to equip the nurseries, early year's and primary schools classrooms.

Porte-manteaux mural scolaire économique avec 5 crochets doubles. Idéal pour équiper crèches, maternelles et écoles.

Penja-robes de fusta amb 5 ganxos dobles de plàstic de diversos colors. Ideal per a equipar classes d'escola bressol, educació infantil i primària.

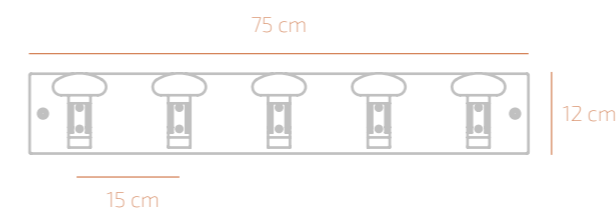

LILY

Ref. 4001



Pizarra blanca con ruedas, imantada y reversible. Cuenta con una bandeja. Ideal para trabajar con diferentes grupos.

Blackboard with castors, reversible and white magnetized. It has a tray. It is ideal to work with different groups.

Tableau magnétique à roulettes et réversible en couleur blanc. Idéal pour travailler en groupes.

Pissarra blanca amb rodes, imantada i reversible. Té una safata. Ideal per a treballar amb diferents grups.

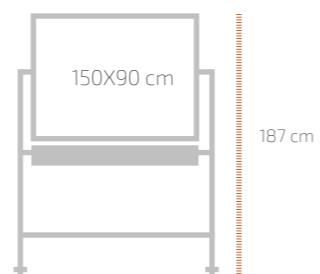

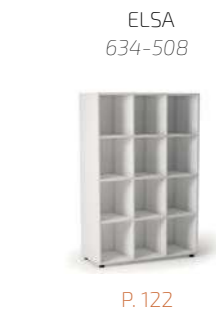

Nuestros productos estan diseñados y fabricados según las normativas de aplicación correspondientes. Relación de normas aplicables:

Sillas y mesas para centros educativos.

UNE EN 1729-1: 07 / UNE EN 1729-2: 07.

Dimensiones, requisitos de seguridad y métodos de ensayo.

Según especificaciones UNE 56.843: 01 mobiliario.

UNE - EN 71-3: 94 - Migración elementos metálicos.

Mirplay certifica sus productos en el laborator de referència internacional

Aidima (Associado nº 1646) y SGS.

Nos produits sont conçus et fabriqués selon les normatives d'application correspondantes. Relation des normes applicables:

Chaises et tables pour centres d'enseignement.

UNE EN 1729-1: 07 / UNE EN 1729-2: 07.

Dimensions, exigences de sécurité et méthodes d'essais.

Selons spécifications UNE 56.843: 01 Mobilier.

UNE - EN 71-3: 94 - Migración d'éléments métalliques.

Mirplay certifie ses produits aux laboratoires de référence internationale

Aidima (Numéro d'associé: 1646) et SGS.

ASSOCIATED N°01646



Las imágenes de este catálogo no tienen un valor contractual. Son ilustrativas y podrían no corresponder exactamente al producto. Las imágenes que aparecen en este catálogo son propiedad de Mobles Mir i Equipaments, queda prohibida su reproducción, distribución, comunicación pública y transformación, sin autorización.

The catalogue's images have not a contractual value. They are illustrative and they cannot correspond exactly with the product. The images shown in this catalogue are property of Mobles Mir i Equipaments, its reproduction, distribution, public communication and transformation are forbidden without authorization.

Les images de ce catalogue n'ont pas de valeur contractuelle. Ils sont illustratifs et peuvent ne pas correspondre exactement au produit. Les images qui apparaissent dans ce catalogue sont de la propriété de Mobles Mir i Equipaments, toute reproduction, diffusion, communication publique et transformation sont interdites sans autorisation.

Les imatges d'aquest catàleg no tenen valor contractual. Són il·lustratives i podrien no correspondre exactament al producte. Les imatges que apareixen en aquest catàleg són propietat de Mobles Mir i Equipaments, queda prohibida la seva reproducció, distribució, comunicació pública i transformació, sense autorització.

Our products are designed and manufactured according to the corresponding implementation regulations:

Chairs and tables for educational institutions.

UNE EN 1729-1: 07 / UNE EN 1729-2: 07.

Dimensions, safety requirements and test methods.

According to UNE 56843:01 furniture specifications.

UNE-EN 71-3:94 - Migration of metallic elements.

Mirplay certifies its products in European laboratories Aidima

(Associate number 1646) and SGS.

Els nostres productes estan dissenyats i fabricats segons les normatives d'aplicació corresponents. Relació de normes aplicables:

Cadires i taules per a centres d'ensenyament.

UNE EN 1729-1: 07 / UNE EN 1729-2: 07.

Dimensions, requisits de seguretat i mètodes d'assaig.

Segons especificacions UNE 56.843: 01 mobiliari.

UNE - EN 71-3: 94 - Migració elements metàl·lics.

Mirplay certifica els seus productes en el laborator de referència internacional

Aidima (Associat núm. 1646) i SGS.

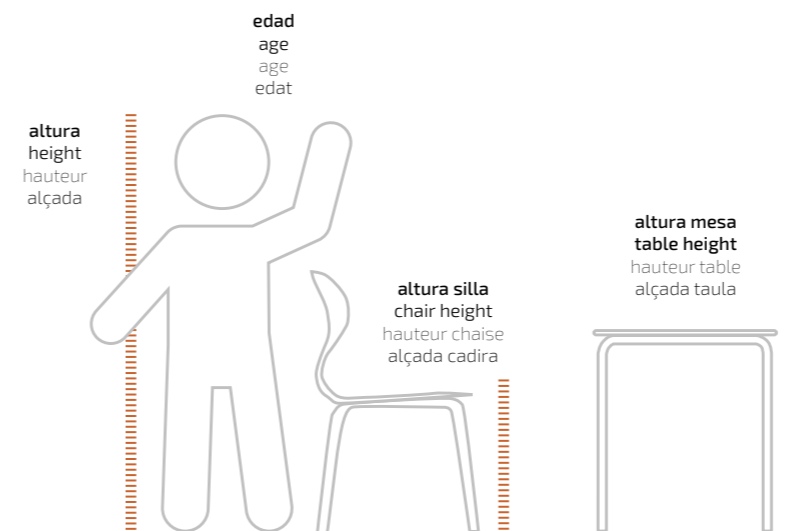

Tallas según la normativa europea UNE-EN 1729-1

Size according to European regulation UNE-EN 1729-1

Taille selon la norme européenne UNE-EN 1729-1

Talles segons la normativa europea UNE-EN 1729-1

TALLA SIZE TAILLE TALLA	EDAD AGE AGE EDAT	ALTURA HEIGHT HAUTEUR ALÇADA	ALTURA ASIENTO CHAIR HEIGHT HAUTEUR SIÈGE ALÇADA SEIENT	ALTURA MESA TABLE HEIGHT HAUTEUR TABLE ALÇADA TAULA
0	1-2	80-95 cm	21 cm	40 cm
1	2-3	93-116 cm	26 cm	46 cm
2	3-4	108-121 cm	30 cm	52 cm
3	4-6	119-142 cm	34 cm	59 cm
4	6-8	133-159 cm	38 cm	65 cm
5	8-10	146-176 cm	42 cm	70 cm
6	+12	159-188 cm	46 cm	77 cm
8*	+8	+146 cm	80 cm	100 cm

*Equivalència UNE-EN 1729-1 a dimensions talla 5 para mesas de trabajo de pie.

*Equivalence UNE-EN 1729-1 size 5 dimensions for tables to work standing up.

*Equivalence UNE-EN 1729-1 aux dimensions 5 pour les tables de travail debout.

*Equivalència UNE-EN 1729-1 a dimensions talla 5 per a taules per treball dempeus.



Mirplay[®] school



HEADQUARTERS

Balenyà, 3 · 08551 Tona · BCN · SPAIN

T: +34 938 124 452

info@mirplayschool.com

www.mirplayschool.com

MIRPLAY MÉXICO

mexico@mirplay.com

MIRPLAY UK

uk@mirplay.com

MIRPLAY ASIA

asia@mirplay.com